

Stereo 290mW 8Ω Speaker Driver **D4800**

DESCRIPTION

The D4800 is an integrated class AB stereo headphone amplifier contained in an SOP8 or a DIP8 plastic package . The D4800 is capable of delivering 290mW of max . output power to an 8Ω load with less than 10% (THD+N) from a 5V power supply . The device has been primarily developed for portable digital audio applications .

FEATURE

- Operating Voltage:

Single Supply	3V to 7V
Dual Supply	±1.5V to 3.5V
- High Signal-to-Noise Ratio 100dB
- High Slew Rate 5V/μs
- Low Distortion -65dB
- Output Power at 10% THD+N

into 8Ω	290mW
into 16Ω	190mW
- Large Output Voltage Swing
- Excellent Power Supply Ripple Rejection
- Low Power Consumption
- Short-circuit Elimination
- Wide Temperature Range
- No Switch ON/OFF Clicks

APPLICATION:

- Portable Digital Audio
- Personal Computers
- Microphone Preamplifier

Outline Drawing

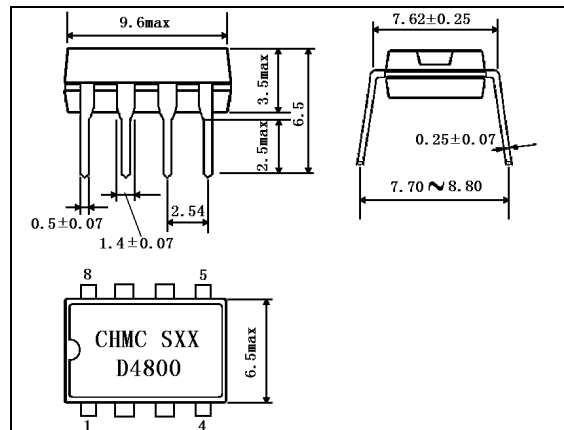

DIP8

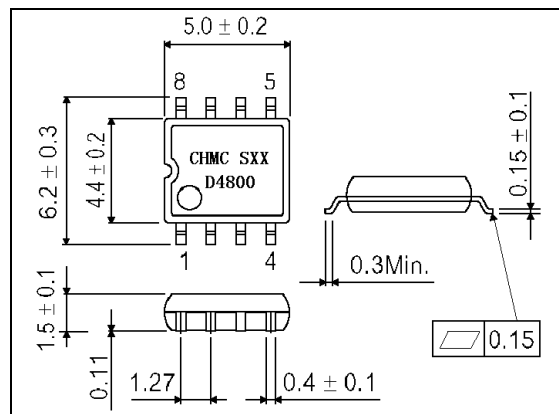

SOP8

PIN CONFIGURATION

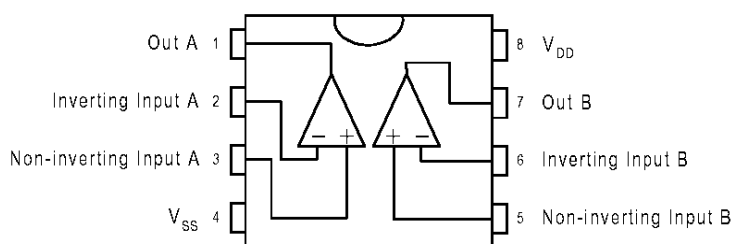

ABSOLUTE MAXIMUM RATINGS

Characteristics	Symbol	Value	Unit
Supply Voltage	V _{DD}	5	V
Output short-circuit Duration at Ta=25°C, P _{TOT} =1W	T _{sc(o)}	20	S
Operating Ambient Temperature range	T _a	-40~+85	°C
Maximum Junction Temperature	T _J	150	°C
Storage Temperature Range	T _{stg}	-65~+150	°C
Soldering Temperature, 10 seconds	T _s	260	°C
Electrostatic Discharge	V _{ESD}	-3000~+3000*	V

*Human body model: C=100pF, R=1500Ω, 3 positive pulses plus 3 negative pulses

THERMAL CHARACTERISTICS

Characteristics		Symbol	Value	Unit
Thermal Resistance from Junction to Ambient in Free Air	DIP8	R _{THJA}	109	K/W
	SOP8		210	

ELECTRICAL CHARACTERISTICS

(Refer to the test circuit, Ta=25°C, f=1kHz, unless otherwise specified)

Characteristics	Symbol	Test Conditions	Min	Typ	Max	Unit
Power Supply Voltage	V _{DD}		2.7		5.5	V
V_{DD}=5V						
Supply Current	I _{DD}	No Load		2.5		mA
Input Offset Voltage				5	50	mV
AC Characteristics						
Total Harmonic Distortion Plus Noise to Signal Ratio	(THD+N)/S	P _O =200mW, R _L =8Ω, f=1kHz P _O =120mW, R _L =16Ω, f=1kHz		0.1 0.05		%
Signal to Noise Ratio	S/N	(THD+N)/S=0.2%, f=1kHz R _L =8Ω R _L =16Ω		210 140		mW

Characteristics	Symbol	Test Conditions	Min	Typ	Max	Unit
AC Characteristics						
Output Power	P _O	(THD+N)/S=10%, f=1kHz R _L =8Ω R _L =16Ω		290 190		mW
Power Supply Rejection	PSRR	C _B =2.2μF, V _{ripple} =200mV _{rms} F=120Hz		55		dB
Noise Floor	V _N	R _L =8Ω		20		rms
V_{DD}=3V						
Supply Current	I _{DD}	No Load		2.2		mA
Input Offset Voltage	V _{I(OS)}			5		mV
AC Characteristics						
Total Harmonic Distortion Plus Noise	(THD+N)/S	P _O =50mW, R _L =8Ω, f=1kHz P _O =40mW, R _L =8Ω, f=1kHz		0.15		%
Output Power	P _O	(THD+N)/S=0.2%, f=1kHz R _L =8Ω R _L =16Ω		60 45		mW
Output Power	P _O	(THD+N)/S=10%, f=1kHz R _L =8Ω R _L =16Ω		90 65		mW

TEST AND APPLICATION CIRCUIT

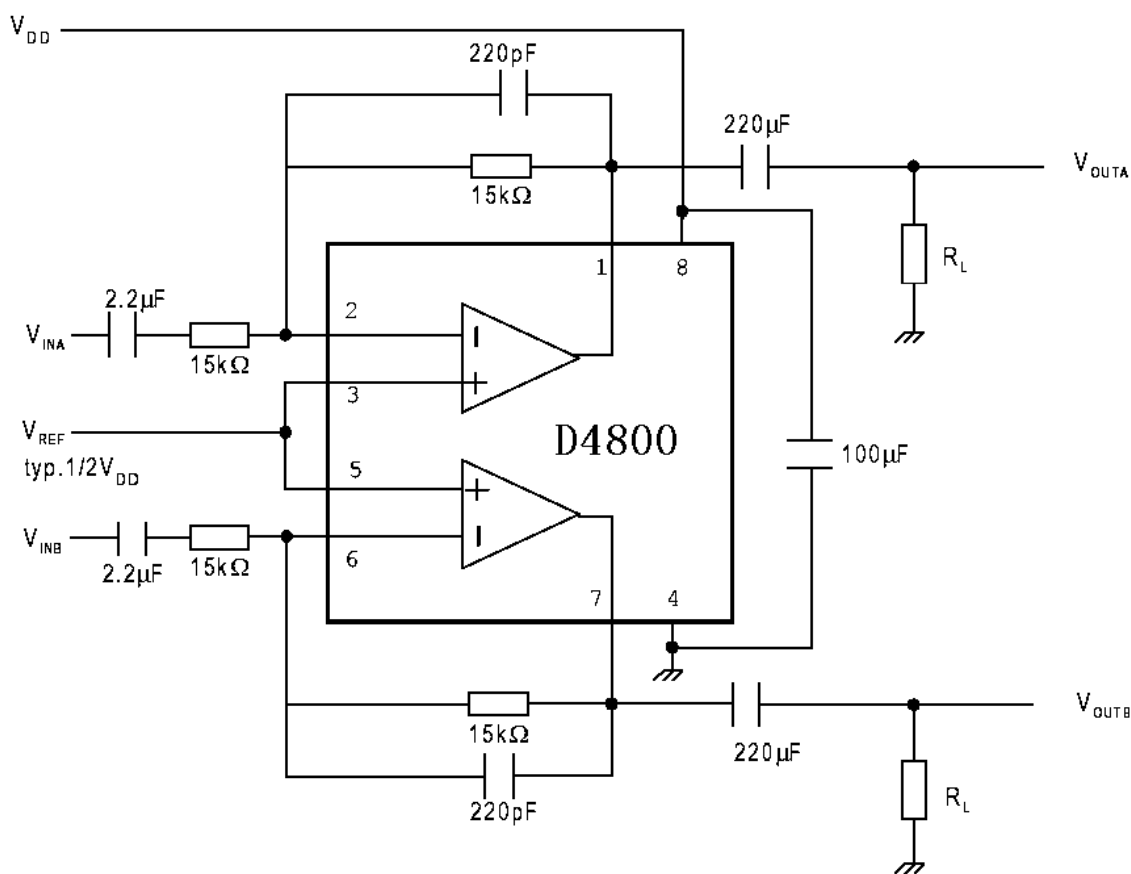

TYPICAL CHARACTERISTICS

THD+N vs Output Power

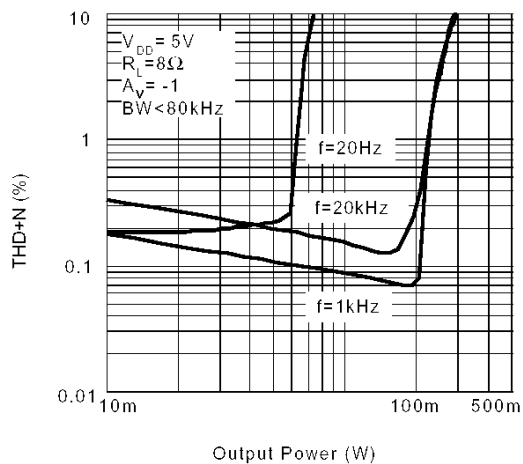

THD+N vs Output Power

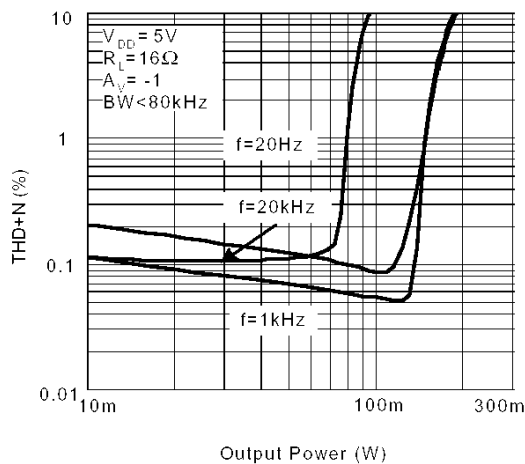

THD+N vs Frequency

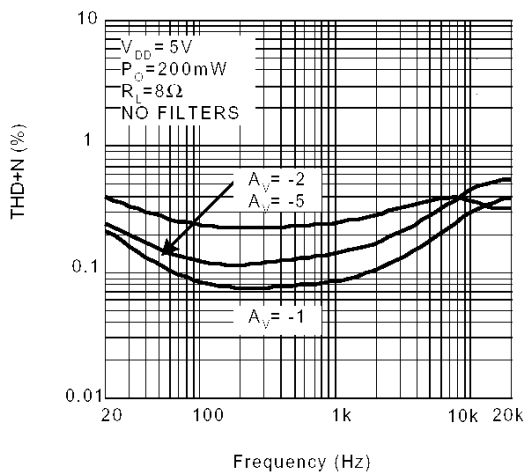

THD+N vs Frequency

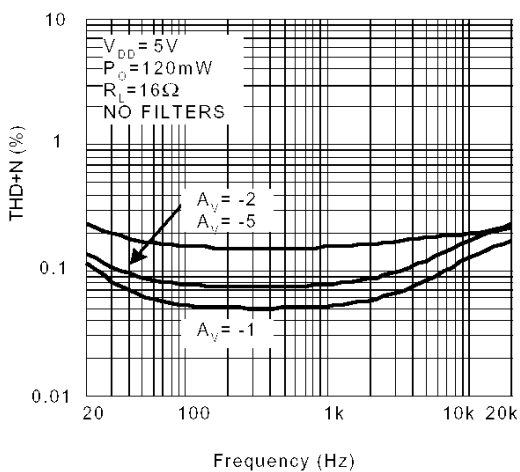

THD+N vs Output Power

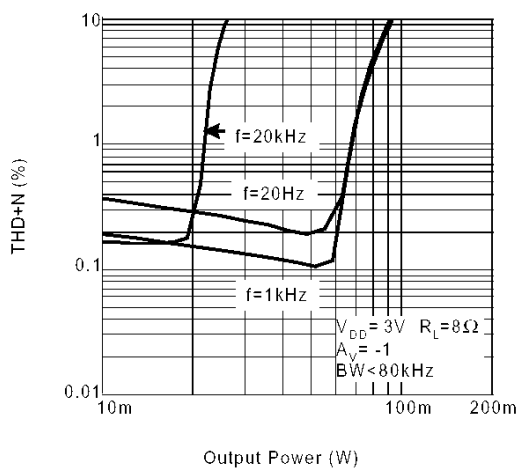

THD+N vs Output Power

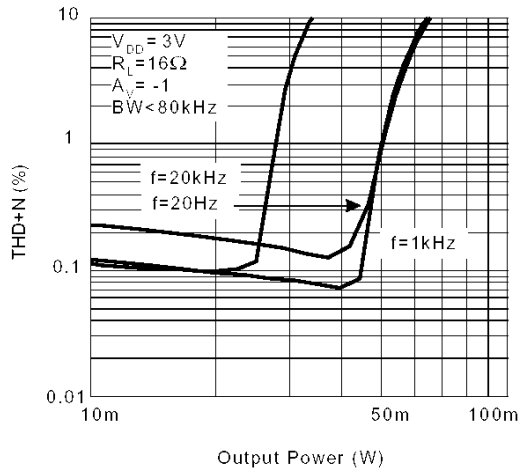

THD+N vs Frequency

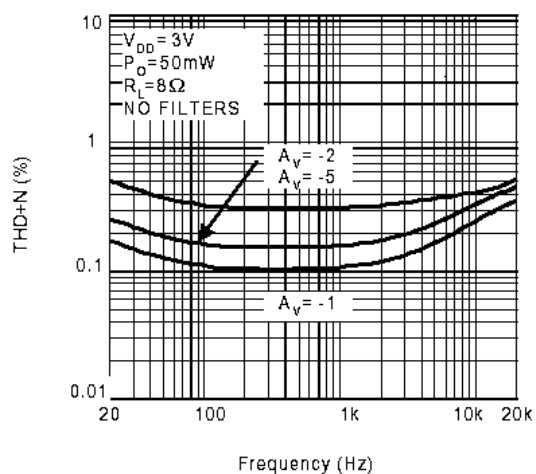

THD+N vs Frequency

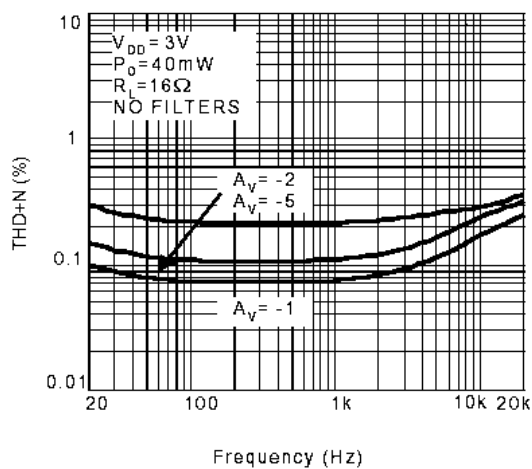

Power Dissipation vs Output Power

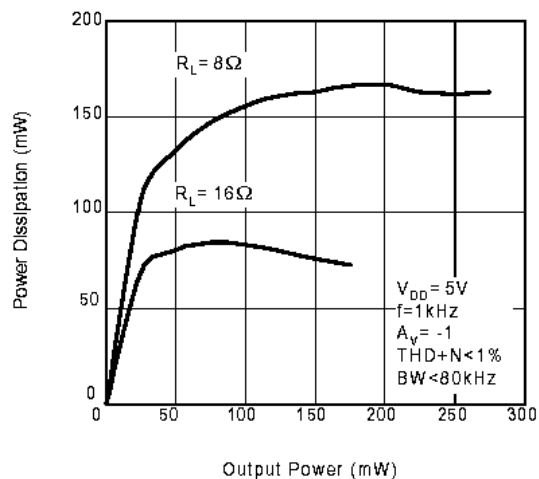

Power Dissipation vs Output Power

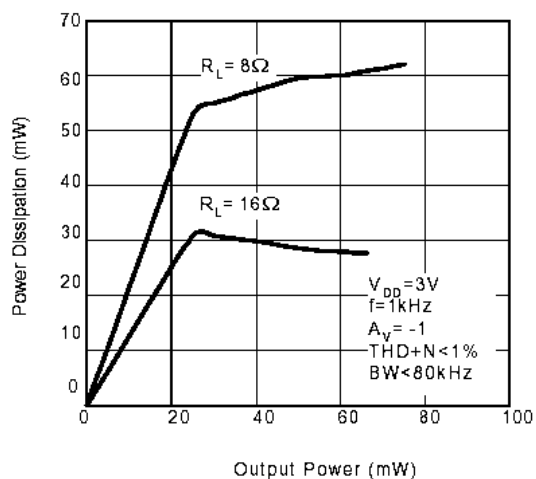

Supply Current vs Supply Voltage

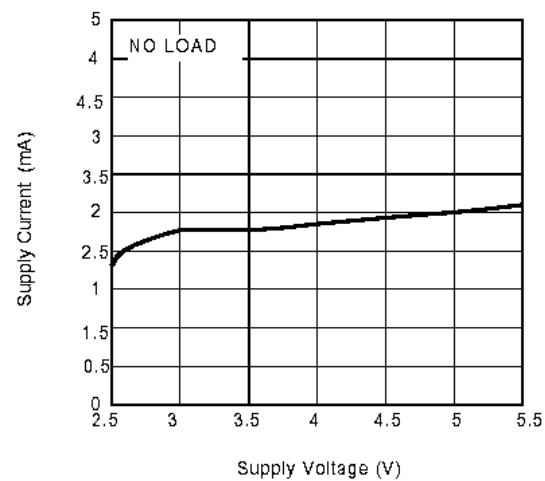

Open Loop Frequency Response

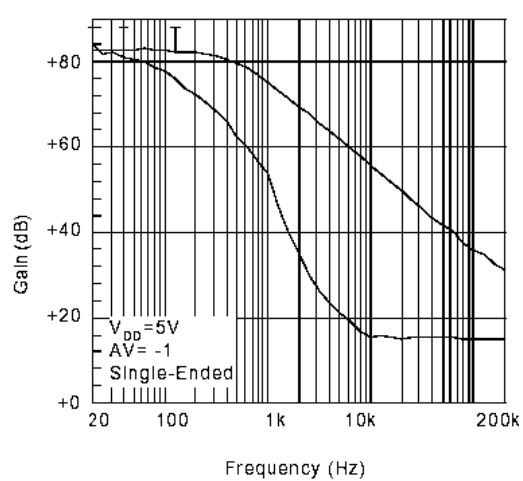

Output Power vs Supply Voltage

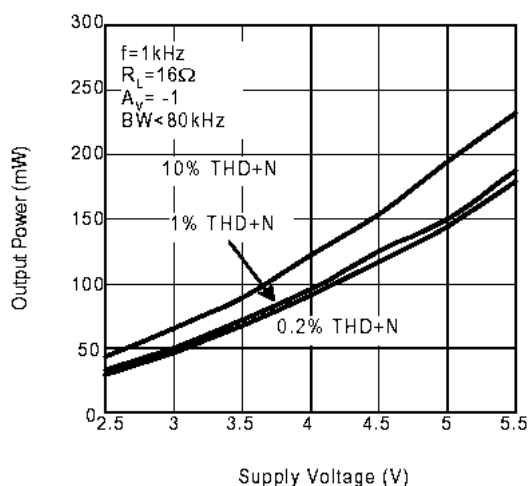

Output Power vs Supply Voltage

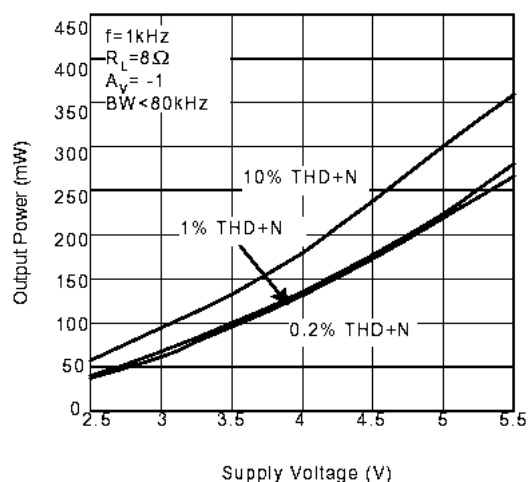

Output Power vs Load Resistance

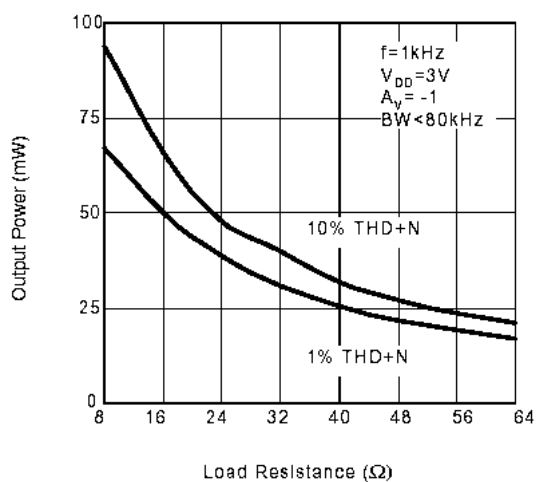

Output Power vs Load Resistance

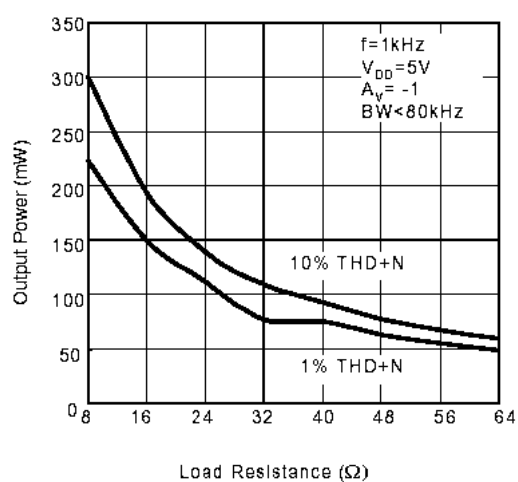

Noise Floor

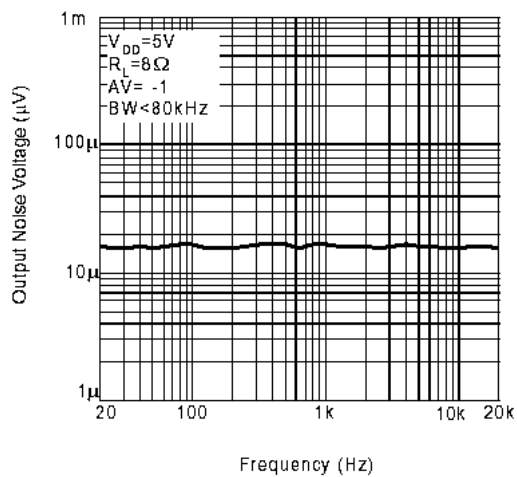

Channel Separation

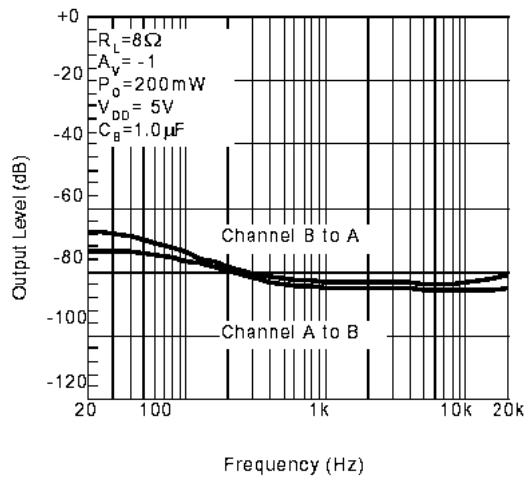

Power Supply Rejection Ratio

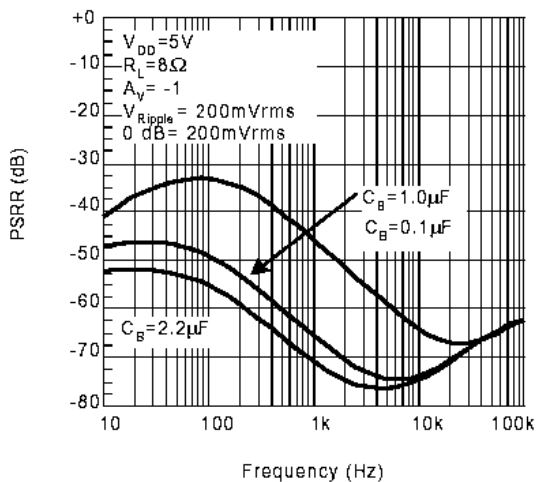

Typical Application Frequency Response

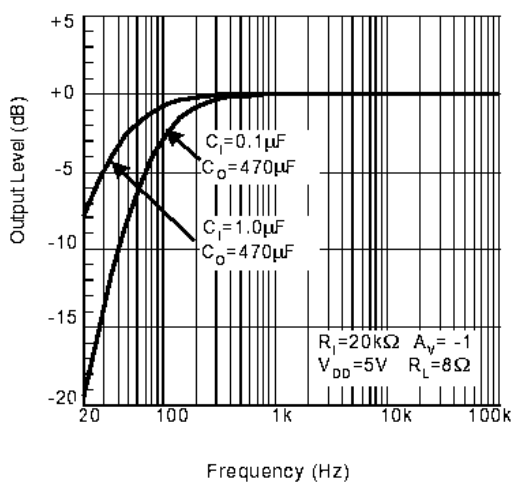

Frequency Response vs Output Capacitor Size

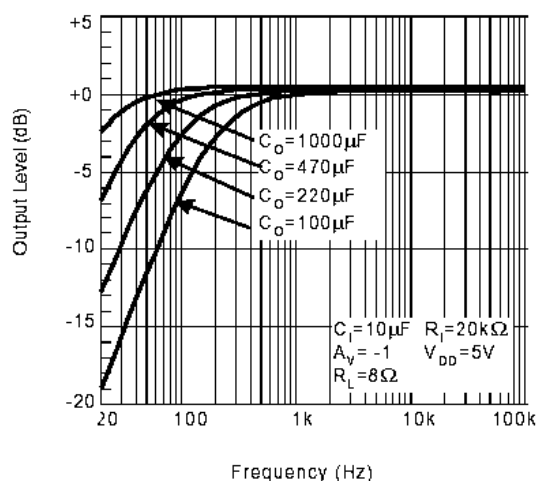

Frequency Response vs Output Capacitor Size

