



带任意限幅的10.9W×2高保真音频功放

■ 特点

- 可任意配置的限幅功能
自由选择音频限制幅度，使输出音频信号限制在固定失真水平内
- 内置自动限温控制功能
- 支持并联单声道 (PBTL)
- 支持AB类与D类切换
- THD+N: 0.02% ($V_{DD} = 8.4V$, $R_L = 4\Omega$, $f_{IN} = 1kHz$, $P_o = 2 \times 1.0W$, BTL)
- 输出功率($f_{IN} = 1kHz$, THD+N = 10%)
2×10.9W ($V_{DD}=9.0V$, $R_L=4\Omega$, BTL)
18W ($V_{DD}=8.4V$, $R_L=2\Omega$, PBTL)
- VDD供电范围：2.5V至9.8V
- 多种增益选择：21dB, 25.5dB, 30dB
- 免滤波器数字调制，直接驱动扬声器
- 保护功能：过流/过热/欠压异常保护功能
- 无铅无卤封装，TSSOP20L-PP

■ 应用

- 蓝牙音箱/智能音响
- 便携式音箱
- 2.1声道小音箱
- 扩音器
- iphone/ipod/ipod docking
- 拉杆音箱
- 平板电脑，笔记本电脑
- 便携式游戏机
- 小尺寸LCD电视/监视器
- MP4, 导航仪

■ 订购信息

Part Number	Output Stage	Package Type	Marking	Operating Temperature Range	MOQ/Shipping Package
HT876BMTET	BTL	TSSOP20L-PP	HT876MTE	-40℃~85℃	Tube / 46PCS
HT876PMTET	PBTL	TSSOP20L-PP	HT876MTE	-40℃~85℃	Tube / 46PCS

■ 概述

HT876是一款立体声D类和AB类音频功率放大器。在D类模式， $V_{DD} = 9.0V$ 、THD+N=10%、4 Ω 负载、1kHz信号条件下，能连续输出2×10.9W功率。

HT876具有可任意配置的限幅(Limiter)功能。限幅功能开启后，即使输入信号很大，音乐输出也能被限制在指定的功率和THD+N之内，满足不同音质体验和喇叭的需求。

HT876还具有自动限温控制(TFB)功能，在高功率输出、高环境温度、AB类模式低效率等情况下导致芯片片内温度较高时，芯片能自动降低系统增益，避免芯片进入过温关断保护模式，在保证音乐品质的前提下显著提升音乐峰值功率。

此外，HT876内部集成免滤波器调制技术，能够直接驱动扬声器，内置的关断功能使待机电流最小化，还集成了输出端过流保护、片内过温保护和电源欠压异常保护等功能。



2×10.9W Class D Audio Amplifier with Flexible Limiter

■ FEATURES

- Flexible Limiter Function adjusted by outside resistor so that the output music is limited under a preset THD+N and power
- Integrated Thermal Foldback (TFB) Function Significantly increase the peak audio power
- Paralleled Bridge Tied Load (PBTL)
- Both Class D and Class AB is available
- THD+N: 0.02% (V_{DD} = 8.4V, R_L = 4Ω, f_{IN} = 1kHz, P_o = 2×1.0W, BTL)
- Output Power (f_{IN} = 1kHz, THD+N = 10%)
2×10.9W (V_{DD}=9.0V, R_L=4Ω, BTL)
18W (V_{DD}=8.4V, R_L=2Ω, PBTL)
- Power Supply V_{DD}: 2.5V~9.8V
- Multiple Gain Available: 21dB, 25.5dB, 30dB
- Filter-less Modulation
- Thermal/Low voltage malfunction prevention function with auto recovery
- Pb-free Packages, TSSOP20L-PP

■ APPLICATIONS

- Bluetooth/Smart Speakers
- Portable Speakers
- 2.1Channel Speakers
- Megaphone
- Portable Gamers
- MP4, GPS
- LCD TV/Monitor
- Tablet PC/Note Book

■ DESCRIPTION

HT876 is a stereo Class D and Class AB audio amplifier, which can deliver 2×10.9W (4Ω Load, BTL mode) power at the condition of V_{DD} = 9.0V, THD+N = 10%, 1kHz sine wave in Class D mode.

HT876 integrates adjustable Limiter Function, which can be set by a resistor at the LIM pin to ground or AVDD, so that the output music can be limited below the preset power and THD+N.

The HT876 Thermal Foldback (TFB) is designed to protect the HT876 from excessive die temperature in case of the device being operated beyond the recommended temperature or power limit (more easily happened in Class AB mode), or with a weaker thermal system than recommended. The TFB works by reducing the on-die power dissipation by reducing Gain if the temperature trig point is exceeded, so that the peak audio power is significantly increased.

HT876 has a filter-less modulation circuit which can directly drive speakers. HT876 can be shut down so that the power consumption can be minimized. As for protection function, over temperature protection function and low supply voltage malfunction preventing function are also prepared.

■ ORDERING INFORMATION

Part Number	Output Stage	Package Type	Marking	Operating Temperature Range	MOQ/Shipping Package
HT876BMTET	BTL	TSSOP20L-PP	HT876MTE	-40℃~85℃	Tube / 46PCS
HT876PMTET	PBTL	TSSOP20L-PP	HT876MTE	-40℃~85℃	Tube / 46PCS



■ TYPICAL APPLICATION

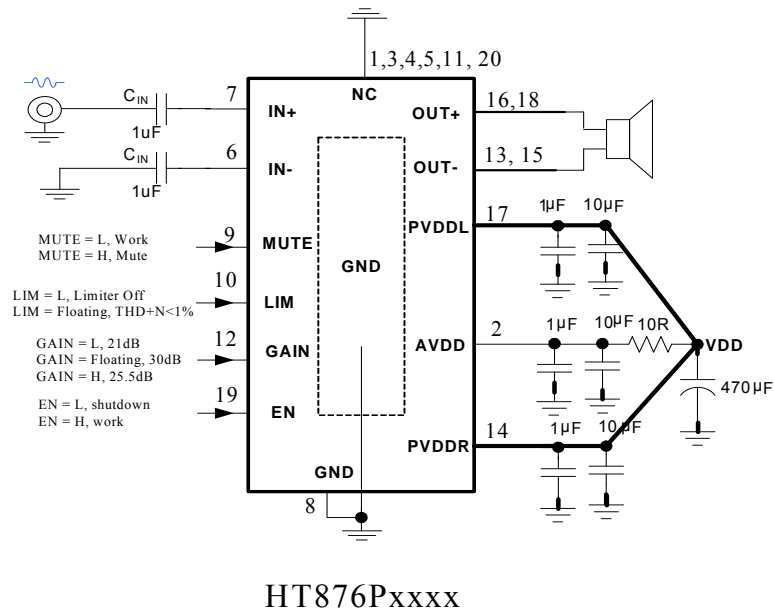
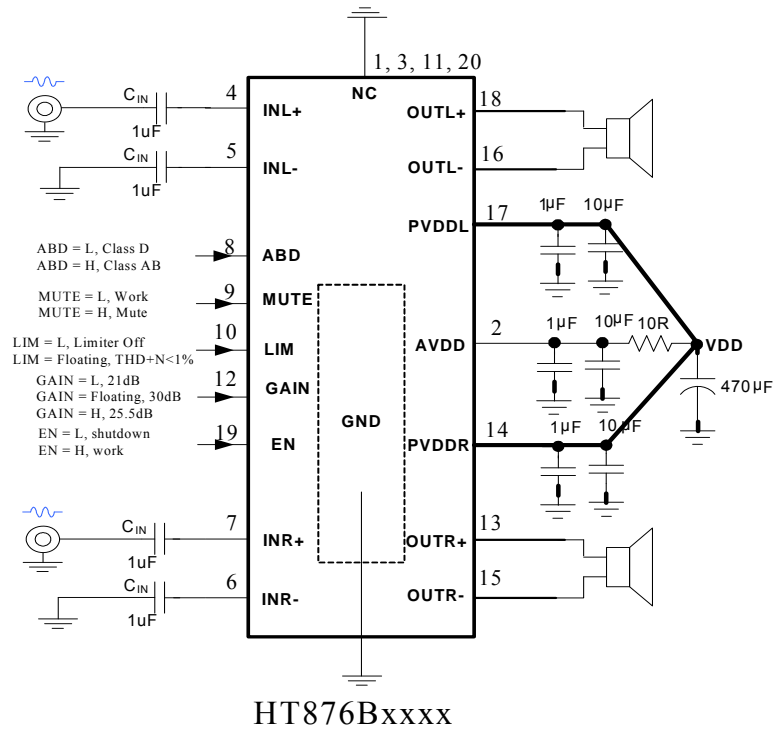



■ TERMINAL CONFIGURATION

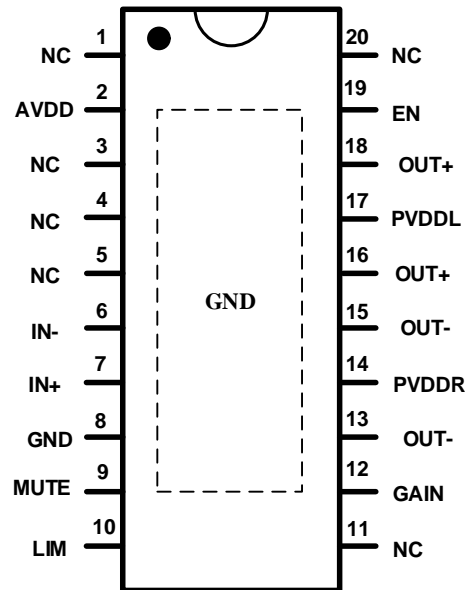
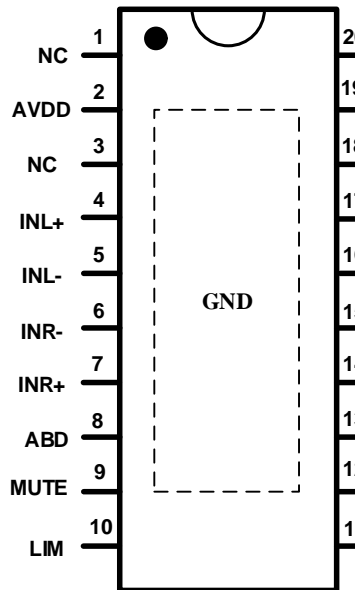

■ TERMINAL FUNCTION¹

HT876B Terminal No.	PIN NAME	I/O	Description
1, 3, 11, 20	NC	/	No connection inside the device, connect to GND for better thermal performance
2	AVDD	P	Analog power supply terminal
4	INL+	I	Positive input terminal (differential+) for left channel
5	INL-	I	Negative input terminal (differential-) for left channel
6	INR-	I	Negative input terminal (differential-) for right channel
7	INR+	I	Positive input terminal (differential+) for right channel
8	ABD	I	Class AB and Class D switch terminal; configure the device to operate in Class AB mode when it is pulled high, and Class D mode when it is pulled low
9	MUTE	I	Mute control terminal; configure the device to operate in mute mode when it is pulled high
10	LIM	I	Limiter function terminal; disable the function when it is pulled low
12	GAIN	O	Gain selection terminal
13	OUTR+	O	Positive output terminal (BTL+) for right channel
14	PVDDR	O	Power supply terminal for right channel
15	OUTR-	O	Negative output terminal (BTL-) for right channel
16	OUTL-	O	Negative output terminal (BTL-) for left channel
17	PVDDL	P	Power supply terminal for left channel
18	OUTL+	O	Positive output terminal (BTL+) for left channel
19	EN	I	Enable terminal; the device goes into shutdown mode when it is pulled low
PAD	GND	G	Power ground

¹ I: input, O: output, P: power, G: ground



■ ELECTRICAL CHARACTERISTIC

● Absolute Maximum Ratings¹

PARAMETER	Symbol	MIN	MAX	UNIT
Supply voltage range (PVDDL, PVDDR, AVDD)	V _{DD}	-0.3	10.8	V
Input voltage range	V _{IN}	-0.3	V _{DD} +0.3	V
Operating temperature range	T _A	-40	85	°C
Operating junction temperature range	T _J	-40	150	°C
Storage temperature range	T _{STG}	-50	150	°C

● Recommended Operating Conditions

PARAMETER	Symbol	CONDITION	MIN	TYP	MAX	UNIT
V _{DD} supply voltage range	V _{DD}		2.5		9.8	V
High-level input voltage of PBTL, ABD, MUTE, GAIN, EN	V _{IH}		1.5			V
Low-level input voltage of PBTL, ABD, MUTE, GAIN, EN	V _{IL}				0.3	V
Operating temperature	T _a		-40	25	85	°C
Load impedance	R _L	BTL		4		Ω
		PBTL		2		Ω

● Electrical Characteristics²

Condition: T_a=25°C, V_{DD} = 2.5~9.8V, f_{IN} = 1 kHz, Gain = 25.5dB, C_{IN} = 1uF, Limiter Off, Load = 4ohm, unless otherwise specified.

PARAMETER	Symbol	CONDITION	MIN	TYP	MAX	UNIT
V _{DD} supply voltage range	V _{DD}		2.5		9.8	V
Start-up time	t _{ON}	Including the mode shifting between Class D and Class AB		50		ms
Shutdown quiescent current	I _{SD}	Input Grounded, With or without load		1		μA
Closed-loop voltage gain	Gain	GAIN = L		21		dB
		GAIN = H		25.5		dB
		GAIN = Floating		30		dB

¹ Stresses beyond those listed under absolute maximum ratings may cause permanent damage to the device. These are stress ratings only, and functional operation of the device at these or any other conditions beyond those indicated under recommended operating conditions is not implied. Exposure to absolute-maximum-rated conditions for extended periods may affect device reliability.

² Depending on parts and PCB layout, characteristics may be changed.



Class D, BTL

PARAMETER	Symbol	CONDITION	MIN	TYP	MAX	UNIT
Output Power	P _O	THD+N=1%	V _{DD} = 3.7V, R _L =4Ω	1.44		W
		THD+N=10%		1.80		W
		THD+N=1%	V _{DD} = 5.0V, R _L =4Ω	2.69		W
		THD+N=10%		3.34		W
		THD+N=1%	V _{DD} = 6.5V, R _L =4Ω	4.64		W
		THD+N=10%		5.70		W
		THD+N=1%	V _{DD} = 7.2V, R _L =4Ω	5.75		W
		THD+N=10%		7.00		W
		THD+N=1%	V _{DD} = 8.4V, R _L =4Ω	7.70		W
		THD+N=10%		9.50		W
		THD+N=1%	V _{DD} = 9.0V, R _L =4Ω	8.82		W
		THD+N=10%		10.89		W
		THD+N=1%	V _{DD} = 9.5V, R _L =4Ω	9.81		W
		THD+N=10%		12.11		W
		THD+N=1%	V _{DD} = 3.7V, R _L =8Ω	0.75		W
		THD+N=10%		1.00		W
		THD+N=1%	V _{DD} = 5.0V, R _L =8Ω	1.47		W
		THD+N=10%		1.80		W
		THD+N=1%	V _{DD} = 6.5V, R _L =8Ω	2.50		W
		THD+N=10%		3.10		W
		THD+N=1%	V _{DD} = 7.2V, R _L =8Ω	3.07		W
		THD+N=10%		3.80		W
		THD+N=1%	V _{DD} = 8.4V, R _L =8Ω	4.20		W
		THD+N=10%		5.17		W
THD+N=1%	V _{DD} = 9.0V, R _L =8Ω	4.80		W		
THD+N=10%		5.93		W		
THD+N=1%	V _{DD} = 9.5V, R _L =8Ω	5.35		W		
THD+N=10%		6.60		W		
Total harmonic distortion plus noise	THD+N	P _O =1W, R _L =4Ω, f=1kHz		0.02		%
Noise output voltage	V _N	Differential input floating, Gain = 21dB, f=20Hz~20kHz, A-weighted		127		μV _{rms}
Signal to noise ratio	SNR	Differential input floating, Gain = 21dB, f=20Hz~20kHz, A-weighted, P _O = 1W		84		dB
Output offset voltage	V _{OS}			3		mV
Efficiency	η	V _{DD} = 8.4V, R _L = 4Ω+22uH, THD+N = 1%		90		%
Operating quiescent current	I _{DD}	Input Grounded, With or without load	V _{DD} = 3.6V	7.3		mA
			V _{DD} = 5.0V	9.7		mA
			V _{DD} = 6.5V	12.8		mA
			V _{DD} = 7.2V	14.7		mA
			V _{DD} = 8.5V	20.6		mA
Cross Talk	CT	P _O = 1W, f _{IN} = 1kHz	L to R	92		dB
			R to L	80		dB
Class D switching frequency	f _{Class-D}			470		kHz



Class D, PBTL

PARAMETER	Symbol	CONDITION		MIN	TYP	MAX	UNIT
Output Power	P _o	THD+N=1%	V _{DD} = 3.7V, R _L =3Ω		2.0		W
		THD+N=10%			2.5		W
		THD+N=1%	V _{DD} = 5.0V, R _L =3Ω		3.7		W
		THD+N=10%			4.6		W
		THD+N=1%	V _{DD} = 6.5V, R _L =3Ω		6.3		W
		THD+N=10%			7.85		W
		THD+N=1%	V _{DD} = 7.2V, R _L =3Ω		7.7		W
		THD+N=10%			9.6		W
		THD+N=1%	V _{DD} = 8.4V, R _L =3Ω		10.6		W
		THD+N=10%			13.3		W
		THD+N=1%	V _{DD} = 3.7V, R _L =2Ω		2.8		W
		THD+N=10%			3.5		W
		THD+N=1%	V _{DD} = 5.0V, R _L =2Ω		5.2		W
		THD+N=10%			6.5		W
		THD+N=1%	V _{DD} = 6.5V, R _L =2Ω		8.8		W
		THD+N=10%			11.0		W
		THD+N=1%	V _{DD} = 7.2V, R _L =2Ω		10.8		W
		THD+N=10%			13.5		W
THD+N=1%	V _{DD} = 8.4V, R _L =2Ω		14.8		W		
THD+N=10%			18.4		W		
Total harmonic distortion plus noise	THD+N	P _o =1.0W, R _L =2Ω, f=1kHz			0.06		%
Noise output voltage	V _N	Differential input floating, Gain = 21dB, f=20Hz~20kHz, A-weighted			127		μV _{rms}
Signal to noise ratio	SNR	Differential input floating, Gain = 21dB, f=20Hz~20kHz, A-weighted, P _o = 1W			84		dB
Output offset voltage	V _{OS}				3		mV
Efficiency	η	V _{DD} = 8.4V, R _L = 2Ω+22uH, THD+N = 10%			88		%
Operating quiescent current	I _{DD}	Input Grounded, With or without load	V _{DD} = 3.6V		8.9		mA
			V _{DD} = 5.0V		14.3		mA
			V _{DD} = 6.5V		23.1		mA
			V _{DD} = 7.2V		28.6		mA
			V _{DD} = 8.5V		44.0		mA
Class D switching frequency	f _{Class-D}				470		kHz



Class AB, BTL

PARAMETER	Symbol	CONDITION		MIN	TYP	MAX	UNIT
Output Power	Po	THD+N=1%	V _{DD} = 3.7V, R _L =4Ω		1.43		W
		THD+N=10%			1.78		W
		THD+N=1%	V _{DD} = 5.0V, R _L =4Ω		2.61		W
		THD+N=10%			3.29		W
		THD+N=1%	V _{DD} = 6.5V, R _L =4Ω		4.43		W
		THD+N=10%			5.54		W
		THD+N=1%	V _{DD} = 7.2V, R _L =4Ω		5.40		W
		THD+N=10%			6.78		W
		THD+N=1%	V _{DD} = 8.4V, R _L =4Ω		7.40		W
		THD+N=10%			9.24		W
		THD+N=1%	V _{DD} = 9.0V, R _L =4Ω		8.50		W
		THD+N=10%			10.73		W
		THD+N=1%	V _{DD} = 3.7V, R _L =8Ω		0.78		W
		THD+N=10%			0.99		W
		THD+N=1%	V _{DD} = 5.0V, R _L =8Ω		1.43		W
		THD+N=10%			1.80		W
		THD+N=1%	V _{DD} = 6.5V, R _L =8Ω		2.42		W
		THD+N=10%			3.06		W
		THD+N=1%	V _{DD} = 7.2V, R _L =8Ω		3.00		W
		THD+N=10%			3.75		W
THD+N=1%	V _{DD} = 8.4V, R _L =8Ω		4.08		W		
THD+N=10%			5.10		W		
THD+N=1%	V _{DD} = 9.0V, R _L =8Ω		4.70		W		
THD+N=10%			5.87		W		
Total harmonic distortion plus noise	THD+N	Po=1W, R _L =4Ω, f=1kHz			0.13		%
Noise output voltage	V _N	Differential input floating, Gain = 21dB, f=20Hz~20kHz, A-weighted			127		μV _{rms}
Signal to noise ratio	SNR	Differential input floating, Gain = 21dB, f=20Hz~20kHz, A-weighted, Po = 1W			84		dB
Output offset voltage	V _{OS}				3		mV
Efficiency	η	V _{DD} = 7.2V, R _L = 4Ω+22uH, THD+N = 1%			74		%
Operating quiescent current	I _{DD}	Input Grounded, With or without load	V _{DD} = 3.6V		14.7		mA
			V _{DD} = 5.0V		16.0		mA
			V _{DD} = 6.5V		17.3		mA
			V _{DD} = 7.2V		18.1		mA
			V _{DD} = 8.5V		20.6		mA
			V _{DD} = 9.0V		22.3		mA
Cross Talk	CT	Po = 1W, f _{IN} = 1kHz	L to R		92		dB
			R to L		79		dB



Limiter Function

PARAMETER	Symbol	CONDITION	MIN	TYP	MAX	UNIT
Limiter attack time	t_{A_AGC}			10		ms/dB
Limiter release time	t_{R_AGC}			160		ms/dB
Limiter level (Peak)	V_{LIM_L}	LIM Floating		$0.9 \times V_{POUT}$		V

Over Temperature Protection and Thermal Foldback (TFB) Function

PARAMETER	Symbol	CONDITION	MIN	TYP	MAX	UNIT
Over temperature protection point	OTP			170		°C
Over temperature protection hysteresis	OTP_{hys}			30		°C
Over temperature protection recovery point	OTPR			140		
Thermal foldback trig point	TFB			150		°C
TFB attack time	t_{A_TFB}			640		ms/dB
TFB release time	t_{R_TFB}			1280		ms/dB



TYPICAL OPERATING CHARACTERISTICS

Class D, BTL

Condition: Class D, BTL mode, $V_{DD} = 2.5\sim 9.5V$, $f_{IN} = 1kHz$, Gain = 25.5dB, Limiter off, Load = 4ohm, unless otherwise specified

V_{DD} vs I_{DD}

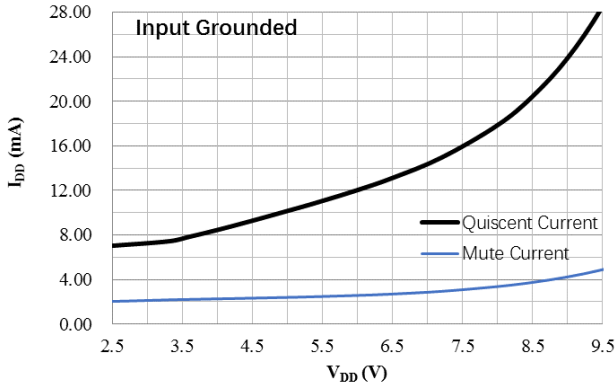

V_{DD} vs P_O

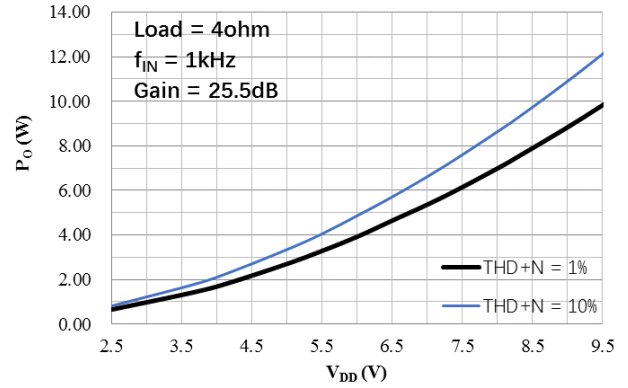

V_{DD} vs P_O

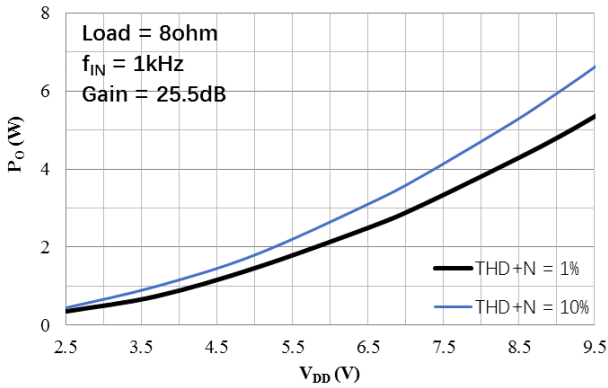

V_{IN} vs V_{OUT}

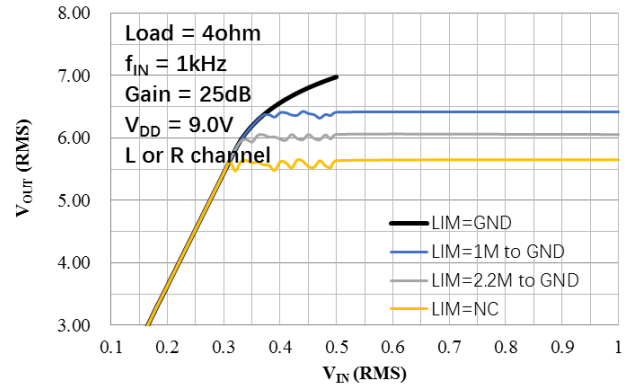

V_{IN} vs V_{OUT}

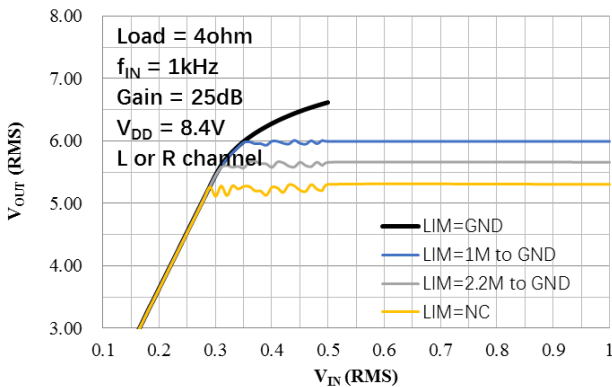

V_{IN} vs V_{OUT}

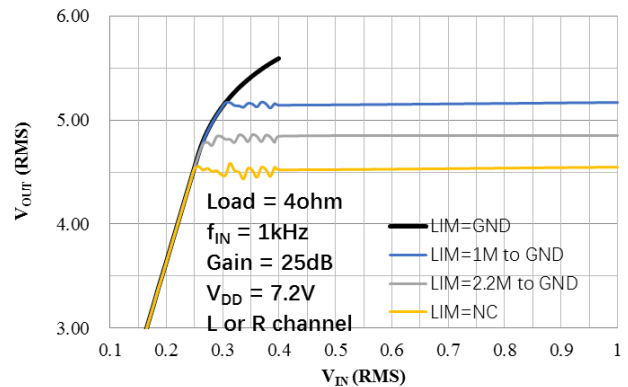



V_{IN} VS V_{OUT}

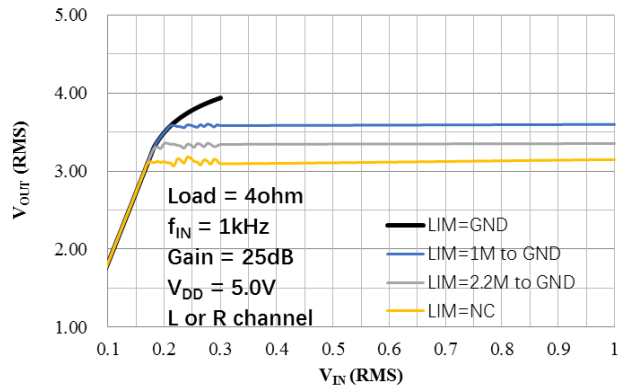

P_O vs THD+N

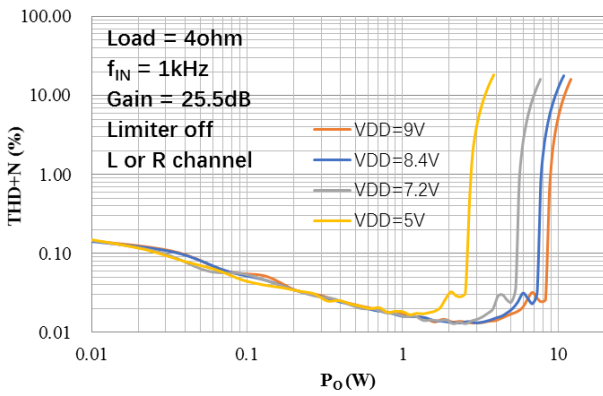

f_{IN} vs THD+N

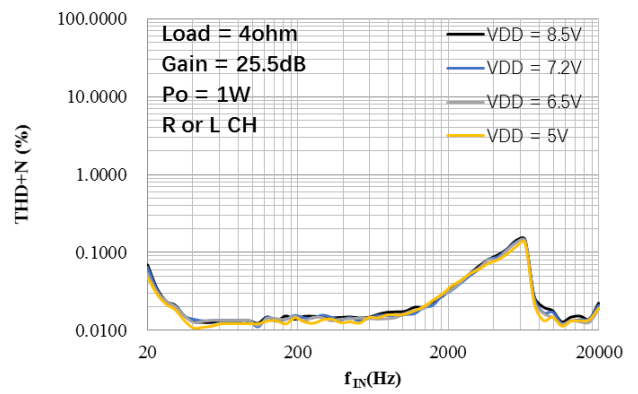

f_{IN} vs Gain

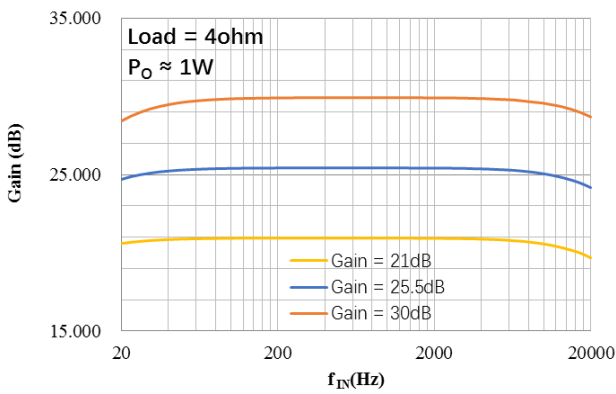

P_O vs η

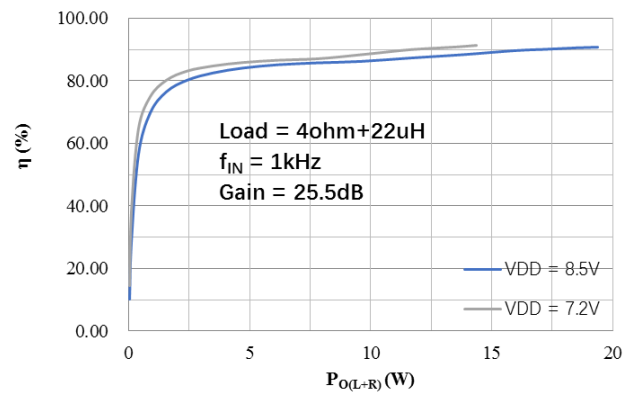



Class D, PBTl

Condition: Class D, PBTl mode, $V_{DD} = 2.5\sim 9.0V$, $f_{IN} = 1kHz$, Gain = 25.5dB, Limiter off, Output = Load + Filter, Load = 4ohm, Filter = 100ohm + 47nF, unless otherwise specified

V_{DD} vs P_O

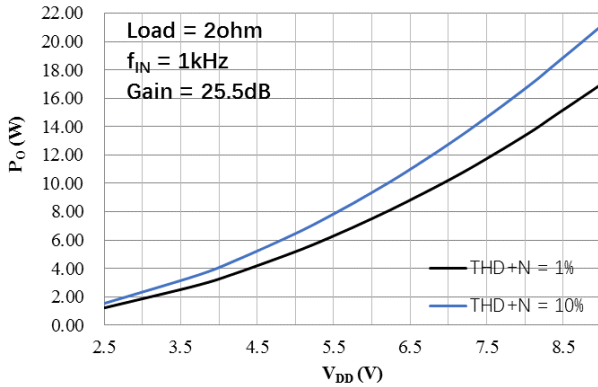

V_{DD} vs P_O

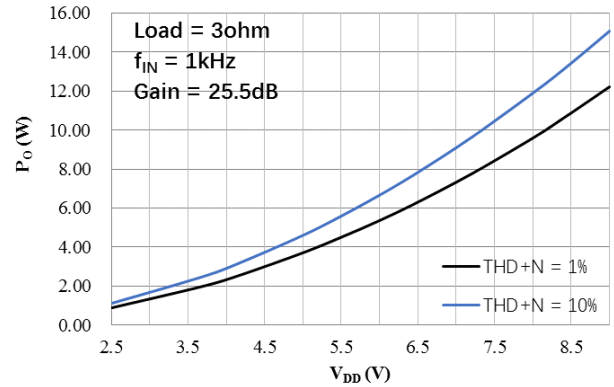

P_O vs THD+N

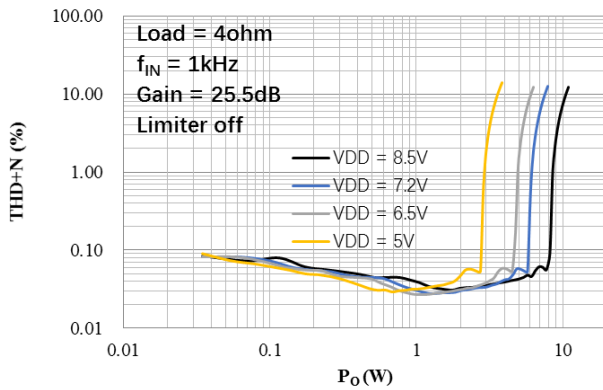

P_O vs THD+N

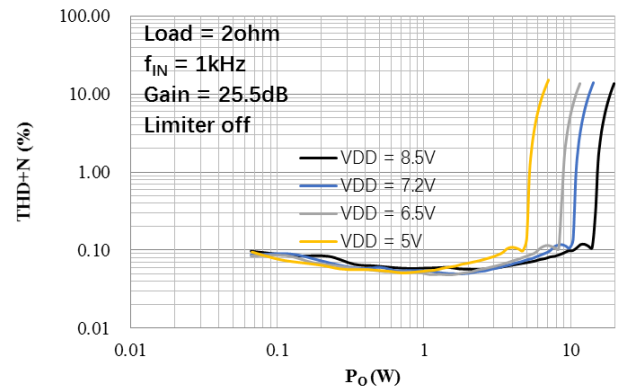

P_O vs THD+N

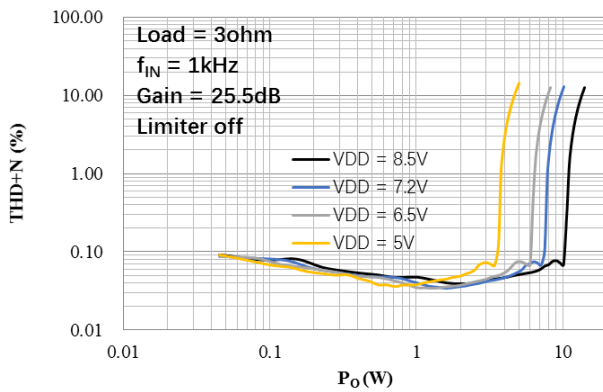

f_{IN} vs THD+N

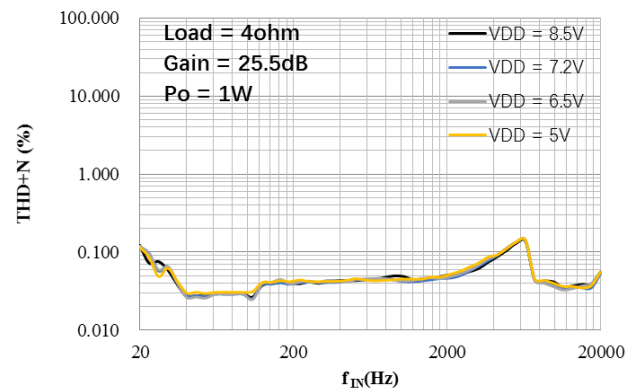



f_{IN} vs THD+N

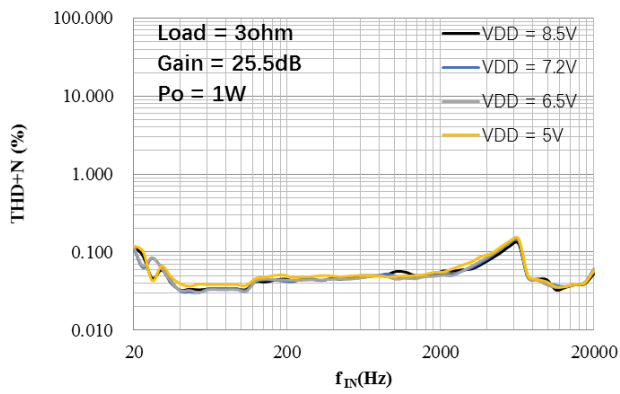

f_{IN} vs THD+N

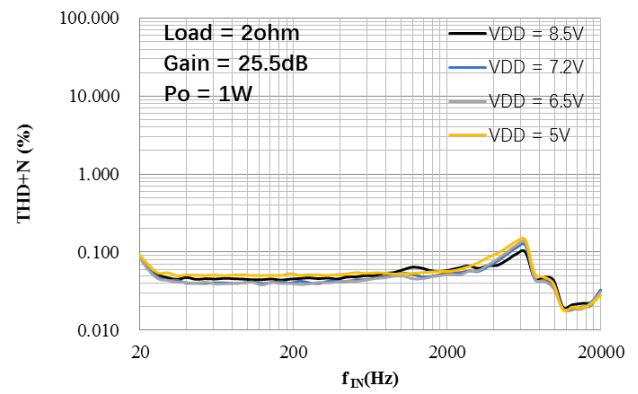

f_{IN} vs Gain

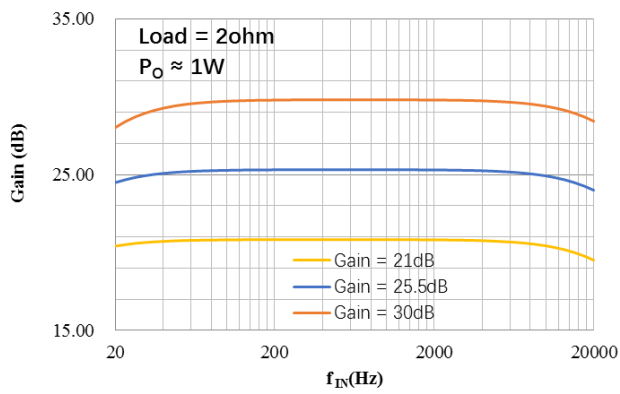

P_o vs η

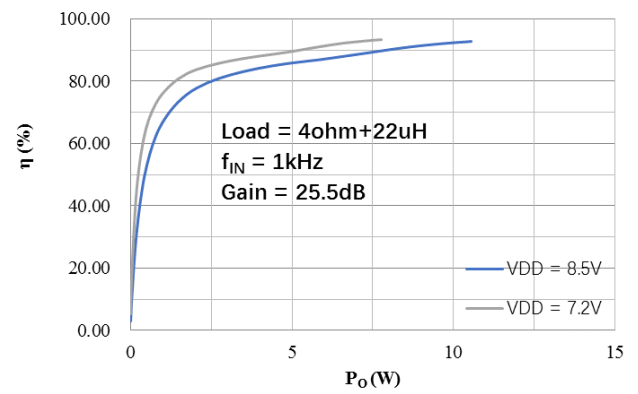

P_o vs η

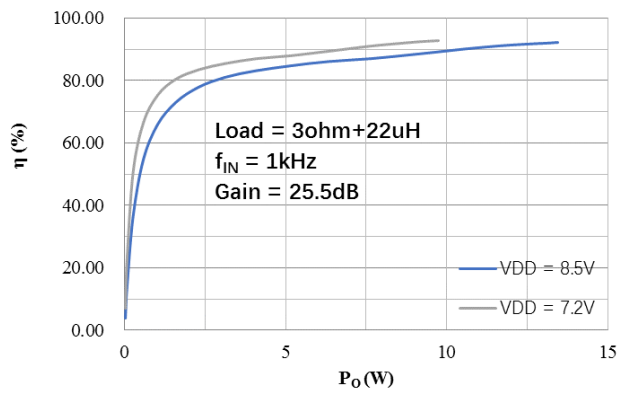

P_o vs η

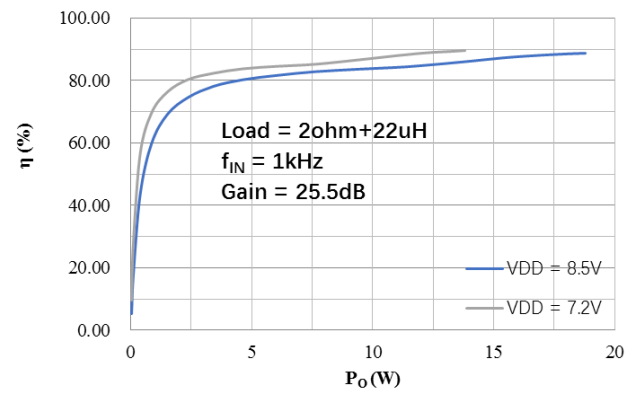



APPLICATION INFORMATION

1. Glossary

Limiter: When Limiter function is active, the output music can be limited below the preset Limiter Level.

Limiter Level: V_{LIM_L} for short. The maximum output voltage allowed before amplifier gain is automatically reduced.

Thermal Foldback: TFB for short. When this function is active, HT862 reduces the on-die power dissipation by reducing system gain if the on-die temperature exceeds the Thermal Foldback Trig Point in case of the device being operated beyond the recommended temperature or power limit, or with a weaker thermal system than recommended. Once the die temperature drops below the TFB trig point, the system gain is increased until the TFB trig point is reached.

Thermal Foldback Trig Point: TFB for short. The on-die temperature trig point for reducing system gain.

Attack Time: t_A for short. The rate of AGC or TFB gain decrease. The default value for AGC Attack Time is 10ms/dB, and the default value of TFB Attack Time is 640ms/dB.

Release Time: t_R for short. The rate of AGC or TFB gain increase. The default value for AGC release time is 160ms/dB, and the default value of TFB Release Time is 1280ms/dB.

2. Feature Description

2.1. Limiter Function (LIM pin)

When Limiter function activates, the output music can be limited below the preset Limiter Level. If the output audio signal exceeds the Limiter Level, HT876 decreases amplifier gain by the rate of attack time (default value 10ms/dB), 0.25dB per step. HT876 increases the gain by the rate of release time (default value 160ms/dB), 0.25 per step, once the output audio is below the limiter level. Figure 1 shows this relationship.

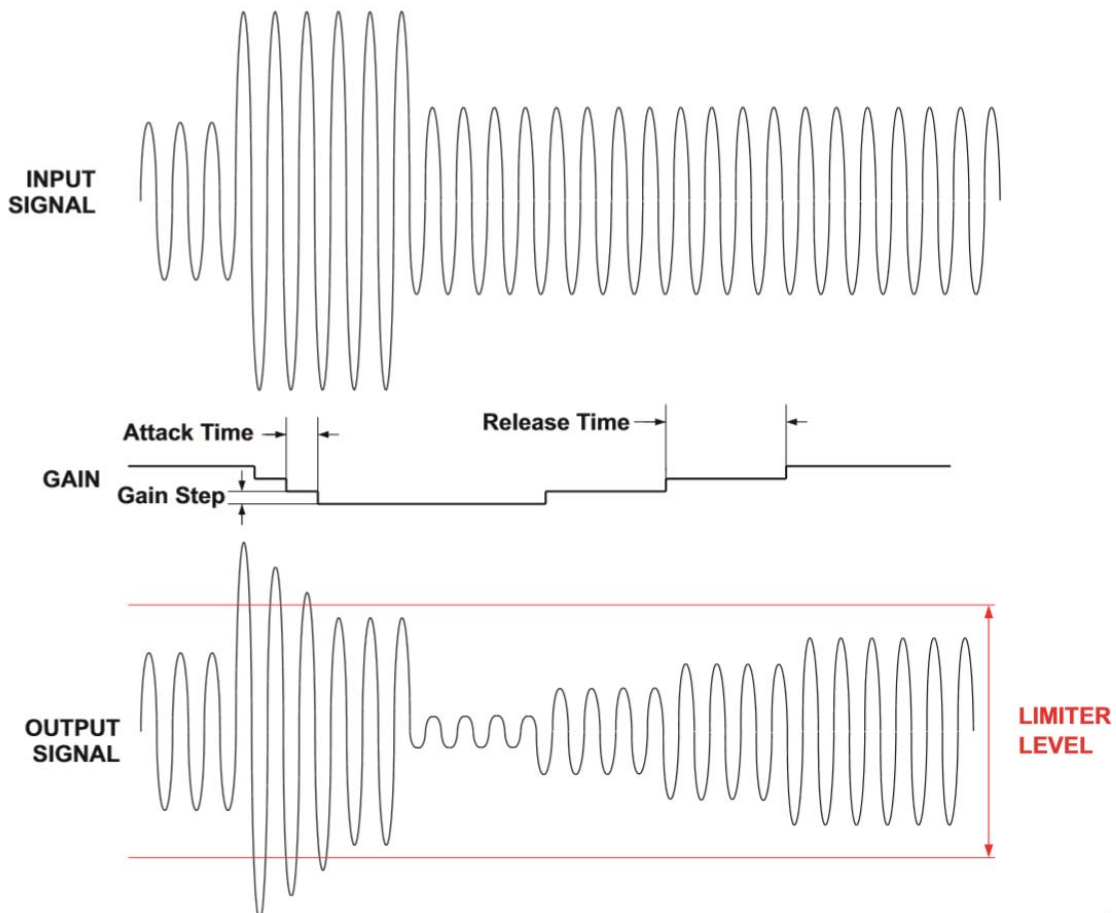

Fig. 1 Limiter Function



The Limiter Level can be modified through LIM terminal. The internal circuit of LIM terminal shows in Fig 2, in which $R_1 \approx 140\text{kohm}$, $R_2 \approx 35\text{kohm}$, $R_3 \approx 105\text{kohm}$. If the LIM terminal is directly grounded, AGC function disabled. To obtain a different Limiter Level, the LIM terminal can be floating, connect a resistor to V_{POUT} , or connect a resistor to Ground. The Limiter Level can be calculated by $V_{\text{LM_L (Peak)}} \approx (0.5V_{\text{POUT}} - V_{\text{LM_COM}}) \times 8$. Typical configurations are shown in the following table.

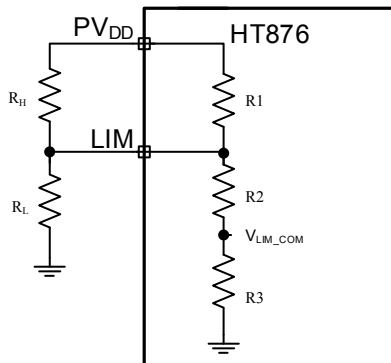

Fig. 2 LIM Terminal Configuration

Table. 1 Typical AGC Limiter Level Configuration

$R_L(\Omega)$	$R_H(\Omega)$	THD+N
NC	NC	< 1%
1M	NC	$\approx 6\%$
2.2M	NC	$\approx 3\%$
Short	NC	AGC Disabled

2.2. Thermal Foldback

The HT876 Thermal Foldback, TFB, is designed to protect the HT876 from excessive die temperature in case of the device being operated beyond the recommended temperature or power limit, or with a weaker thermal system than recommended. The TFB works by reducing the on die power dissipation by reducing the HT876 system gain by the rate of attack time (default value 640ms/dB) in steps of 0.25dB if the TFB trig point (default value 150°C) is exceeded. Once the die temperature drops below the TFB trig point, the HT876 gain is increased by a single or by the rate of release time (default value 1280ms/dB) in steps of 0.25dB until the TFB trig point, or a maximum of 30dB attenuation is reached, and the system gain will be decreased again, or the system gain is at its nominal gain level. The procedure shows as follows.

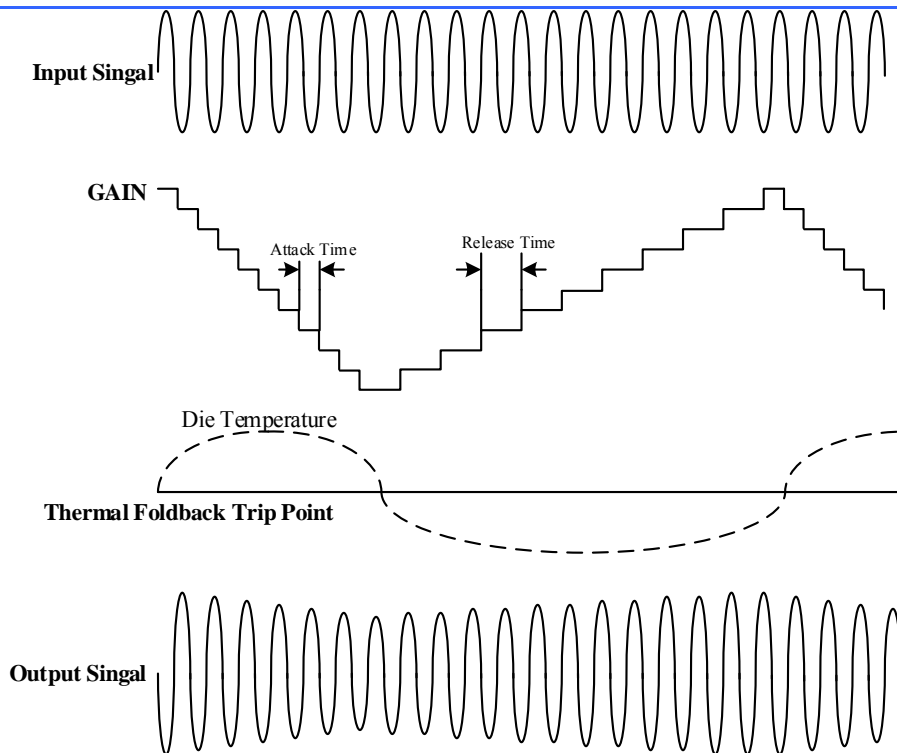

Fig. 3 Thermal Foldback Operation

2.3. Audio Amplifier Input Configuration

HT876 is an amplifier with analog input (single-ended or differential), that can directly drive a speaker. For a differential operation, input signals into IN+ and IN- pins via DC-cut capacitors (C_{IN}) and external input resistors R_{IN}. The input signal gain is calculated by $Gain \approx 12dB + R_F / (External R_{IN} + Internal R_{IN})$. And the

high pass cut-off frequency of input signal can be calculated by $f_c = \frac{1}{2\pi(External R_{IN} + External R_{IN}) \times C_{IN}}$.

For a single-ended operation, input signals to IN+ pin via a DC-cut capacitor (C_{IN}) and external input resistor (R_{IN}). IN- pin should be connected to ground via a DC-cut capacitor and external input resistor (R_{IN}) (with the same value of C_{IN} and R_{IN}). The Gain and high pass Cut-off frequency are the same as the above case.

The values of internal R_{IN} and R_F is shown in Table. 2.

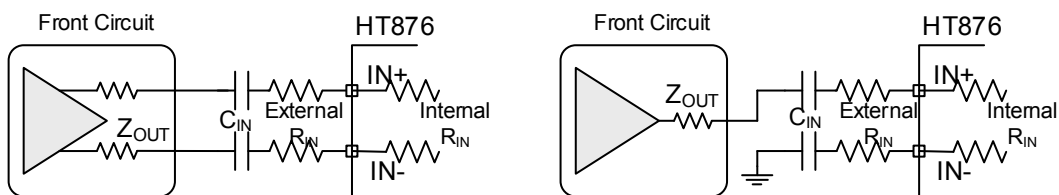

Fig. 4 (1) Differential Input;;

(2) Single-ended Input

Table. 2 Internal input resistors and feedback resistors

GAIN	Internal R _{IN} (ohm)	R _F (ohm)
21dB	36k	102k
25.5dB	24k	114k
30dB	15.4k	122.8k



2.4. Amplifier Output

As mentioned before, HT876 can directly drive speakers without any other components. But there are exceptions. Once HT876 works in Class D mode, the cable lined to the speaker is very long, and EMI is concerned, ferrite beads or L-C filter is needed.

2.5. SD mode configuration (EN pin)

When EN terminal is pulled logic high, HT876 works in normal mode.

When EN terminal is pulled logic low, HT876 works in Shutdown mode.

Notice that a pull-down resistor from EN pin to GND is placed inside the chip, the resistor value is about 300kohm.

2.6. Parallel Bridge Tied Load Mode Select (PBTL pin)

The HT876 can be configured to drive a single speaker with the two output channels connected in parallel. This mode of operation is called Parallel Bridge Tied Load (PBTL) mode. This mode of operation effectively reduces the output impedance of the amplifier in half, which in turn reduces the power dissipated in the device due to conduction losses through the output FETs. Additionally, since the output channels are working in parallel, it also doubles the amount of current the speaker amplifier can source before hitting the over-current error threshold. However, this mode is only available when HT876 is working in Class D mode.

When PBTL terminal is pulled logic high, HT876 works in PBTL mode. In PBTL mode, the amplifier selects its source signal from the right channel (INR+ and INR-).

When PBTL terminal is pulled logic low, HT876 works in normal BTL mode.

2.7. ABD Terminal Mode Control (ABD pin)

When ABD terminal is pulled logic high, HT876 works in Class D mode.

When ABD terminal is pulled logic low, HT876 works in Class AB mode.

Notice that a pull-down resistor from ABD pin to GND is placed inside the chip, the resistor value is about 300kohm.

2.8. Mute Mode Select (MUTE pin)

When MUTE terminal is pulled logic high, HT876 works in mute mode, in which the differential output signal becomes Weak Low state (a state grounded through high resistivity).

When MUTE terminal is pulled logic low, HT876 returns to the normal working state.

Notice that a pull-down resistor from MUTE pin to GND is placed inside the chip, the resistor value is about 300kohm.

2.9. Gain Select (GAIN pin)

The GAIN pin is the terminal to select system gain. There are three different choices as following.

Table. 3 GAIN Terminal Configuration

GAIN	Terminal GAIN
21dB	Logic Low
25.5dB	Logic High
30dB	Floating



2.10. Protection Function

HT876 has the protection functions such as Thermal Protection function, and Low Voltage Malfunction Prevention function.

(1) Thermal Protection function

When excessive high temperature of HT876 is detected, the thermal protection mode starts up. In the thermal protection mode, the differential output terminal becomes Weak Low state (a state grounded through high impedance).

(2) Low voltage Malfunction Prevention function

This is the function to establish the low voltage protection mode when V_{DD} terminal voltage becomes lower than the detection voltage (V_{UVLL}) for the low voltage malfunction prevention. And the protection mode is canceled when V_{BAT} terminal voltage becomes higher than the threshold voltage (V_{UVLH}). In the low voltage protection mode, the differential output pin becomes Weak Low state (a state grounded through high impedance). HT876 will start up within the start-up time when the low voltage protection mode is cancelled.

2.11. Typical Application

HT876Bxxxx, BTL mode

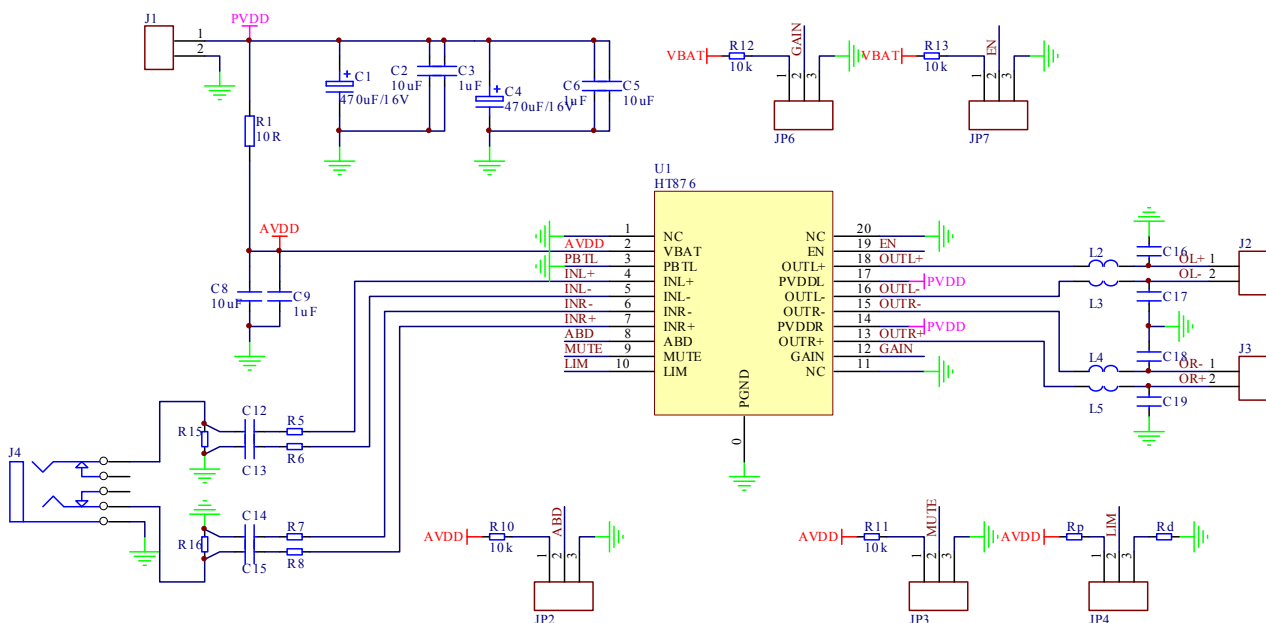



2.12. PCB Layout
HT876Bxxxx, BTL mode

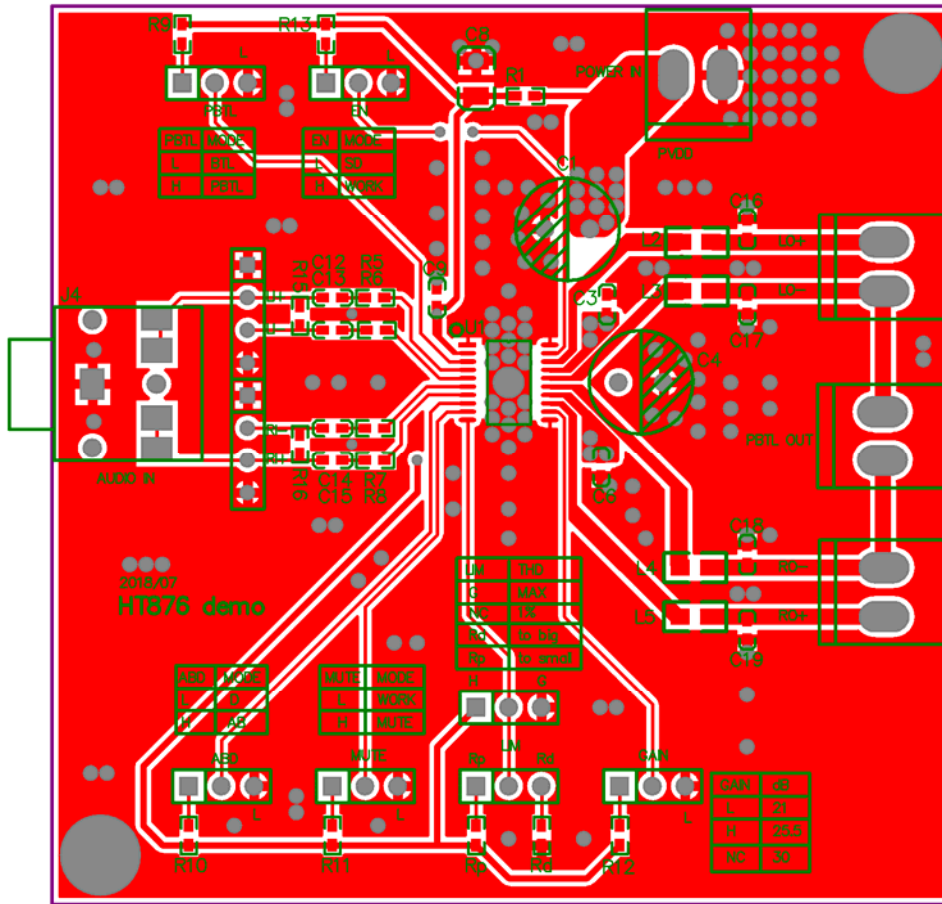

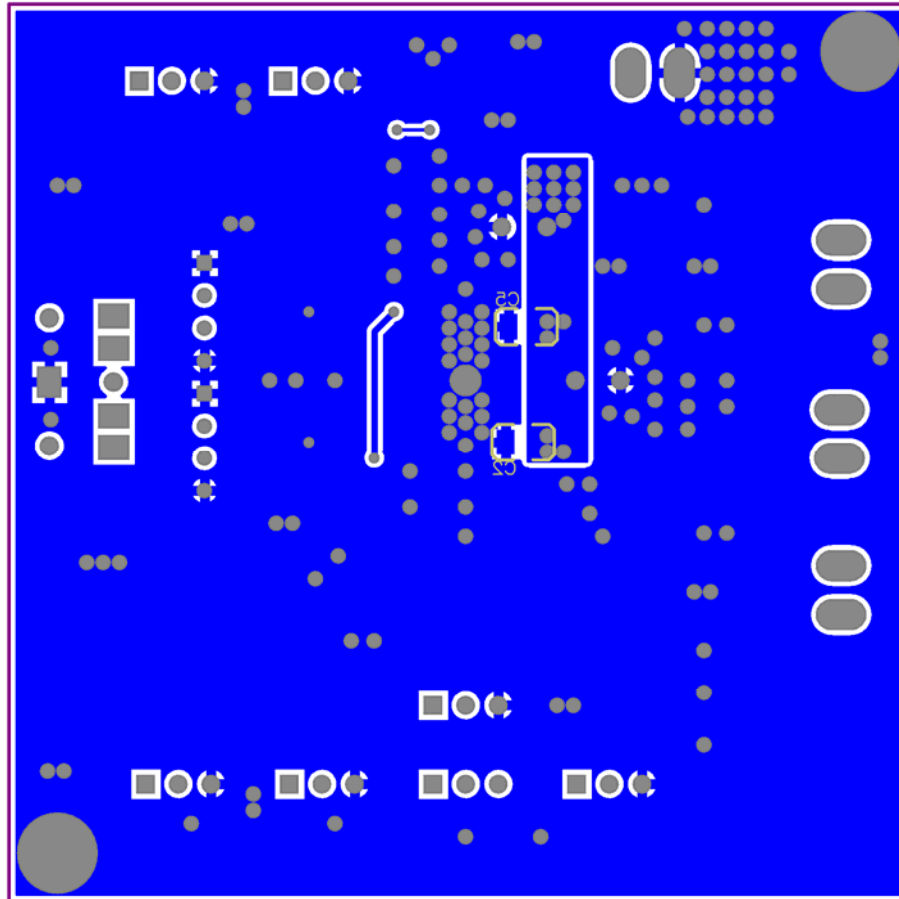



Package Outline – TSSOP20L-PP

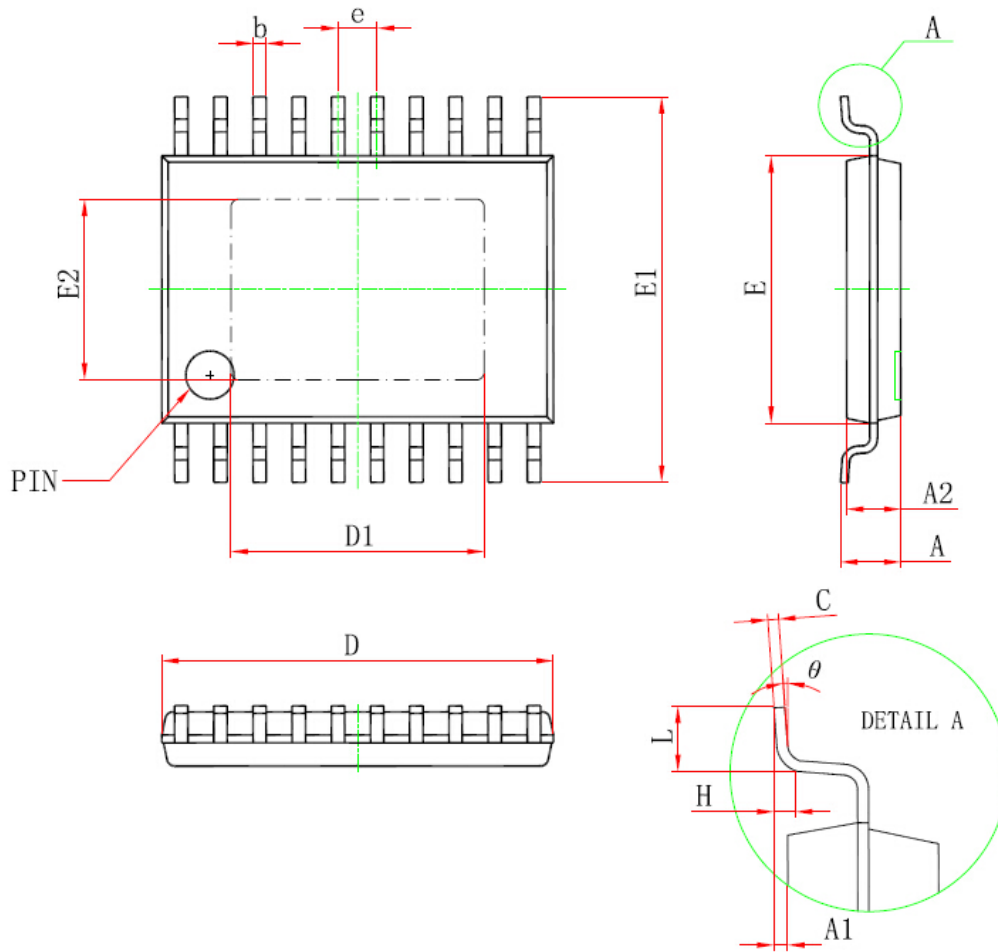

TSSOP20L-PP Package

Symbol	size (mm)		size (inch)	
	min	max	min	max
D	6.400	6.600	0.252	0.259
D1	4.100	4.500	0.165	0.169
E	4.300	4.500	0.169	0.177
b	0.190	0.300	0.007	0.012
c	0.090	0.200	0.004	0.008
E1	6.250	6.550	0.246	0.258
E2	2.900	3.100	0.114	0.122
A		1.100		0.043
A2	0.800	1.000	0.031	0.039
A1	0.020	0.150	0.001	0.006
e	0.65(BSC)		0.026(BSC)	
L	0.500	0.700	0.02	0.028
H	0.25(TYP)		0.01(TYP)	
θ	1°	7°	1°	7°